



HORIZON-C

IP-based capacitive multi-touch color displays



HORIZON

Overview

The HORIZON-C IP-based capacitive multi-touch color display is an ideal user interface for a wide range of HVAC, lighting, and sunblind applications.

HORIZON Series displays provide easy and intuitive access to the internal data of ECLYPSE™ ECY series controllers, and of ECB series BACnet® and ECL series LONWORKS® controllers when they are operating under EC-Net™.

Designed for optimal performances, HORIZON-C's quad-core 64-bit processor integrates a high-end graphical engine, allowing to display any webpage, including highly demanding advanced HTML5 visualization interface pages such as ENVYISION and xpressENVYISION graphics.

This allows you to quickly manage operating parameters of an HVAC system: monitor values, equipment and system status, and view active system alarms to perform diagnostics and take corrective actions such as overriding a sensor, pump, fan, or changing a setpoint.

HORIZON-C displays can be panel mounted (IP65) or in-wall mounted (IP20, with optional in-wall mounting kit), for convenient access to the display where it is needed. Moreover, they feature screen auto-rotation, allowing either vertical (portrait) or horizontal (landscape) effortless installation.

Applications

The HORIZON-C display is typically used for:

- Management and servicing of HVAC equipment, such as air handling units, central plants, and boilers rooms.
- Supervision of small to medium sized buildings.
- Smart Room Control (HVAC, lighting and shades/sunblinds) in small to medium sized room applications

Features & Benefits

Enhanced Browsing

HORIZON-C combines a bright and inviting display with a powerful quad-core processor embedding high-end graphical engine. This makes it the perfect display for navigating in highly-demanding responsive HTML5 web environments.

Moreover, advanced features such as auto-login and self-checking connection optimize the browsing experience.

Capacitive Multi-Touch Screen

Because of its high-end capacitive multi-touch screen, HORIZON-C display responds to the slightest touch and supports gestures such as flicking and zooming, allowing for smartphone-like operation for unparalleled user experience.

HTML5 Visual Interface

ENVYSION is a web-based graphic design and visualization interface used to create and deliver interactive graphical user interfaces and an optimal user experience for building owners and facility managers to better manage facility data.



Combine ENVYSION's powerful capabilities with HORIZON-C's unique touch and feel to create the optimal high-end interface for Smart Room Control solutions. This allows end-users to intuitively manage occupancy, HVAC, lighting and shades/sunblinds, while system integrators can easily program and store specific scenes to be recalled depending on the different room occupancy scenarios.



Moreover, you can use the standard interfaces generated from ECLYPSE and EC-Net systems for fast deployment in time-constrained projects.

IP Communication

This display communicates over IP for increased speed. Experience faster response and save time when configuring your system, or viewing graphics.

For further flexibility, HORIZON Series display addressing can be either configured manually with a static IP address or automatically using DHCP.

Create and set your installation at a glance

Combine *xpressNetwork* Utility, *EC-gfxProgram*, *xpressENVYSION*, and the Productivity Enhancing Tools with ECLYPSE controllers and HORIZON-C display to create and set your installation in no time:

2 / 8

- Use *xpressNetwork* Utility to identify your ECLYPSE Controller and your HORIZON-C display.
- Launch *EC-gfxProgram* directly from *xpressNetwork* Utility to load the pre-engineered application from the Productivity Enhancing Tools library.
- Import the matching graphics in *xpressENVYSION* from the ECLYPSE web interface.
- Create the associated user profile.
- Configure *myDC* Viewer from the HORIZON-C web interface.
- Login to HORIZON-C: your application is up and running.

Web Access

HORIZON-C displays embed a webserver, enabling device configuration directly within the *xpressNetwork* Utility.

This also allows to perform multiple tasks such as user management, firmware updates, device setup, and much more, all remotely from a web browser, just like ECLYPSE controllers.

Multiple Devices Monitoring

Create and save connections for a quick and easy access to different ECLYPSE controllers or EC-Net systems, allowing you to monitor any controller in your installation from a single display.

Adaptive Brightness

HORIZON-C displays are equipped with an ambient light sensor that detects the light level in the environment, and adjusts the display brightness accordingly for optimal reading comfort.

Screen brightness behavior is also fully programmable, allowing you to adjust the screen behavior to your specific installation.

Auto-rotate Feature

HORIZON-C displays integrate a gyroscope that triggers either the horizontal (landscape) or vertical (portrait) mode depending on the mounting scenario. No need for additional configuration: the screen mode automatically adjusts to the installation position.

Versatile Alarm Management

HORIZON-C displays feature a relay output for optional control of external visual and/or acoustic alarm management devices, while the integrated buzzer can eliminate the need for an additional device.

Both the relay and the buzzer can be set independently and linked to any BACnet Notification Class.

Direct Access

Access any ECLYPSE ECY Series controller, or any ECB or ECL Series controller operating under an EC-Net system, and a wide range of their internal functions:

- View the active alarms list and, depending on the controller model, view alarm details to quickly identify issues and acknowledge alarms.
- View, set, and override input and output values to verify and troubleshoot equipment operation first hand to save time.
- Access a list of favorites to rapidly access commonly-used values.

Different Sizes, Same Features

Two models are available: HORIZON-C7 (7") and HORIZON-C10 (10.1").

All models have the same features; simply select the right size to meet your specific needs.

Sleek Design

HORIZON displays provide a clean and sleek appearance when installed in offices or rather cramped electrical rooms.

Moreover, its overall thin form factor makes it suitable for cabinet or in-wall mounting in space constrained areas.

Setup Assistant

HORIZON-C's setup assistant simplifies the installation tasks by providing everything you need for a quick set-up:

- Admin password definition
- IP configuration
- Applications management
- Credential settings for auto-login

This significantly reduces installation time and facilitates wide-scale deployment.

Self-Checking Connection

HORIZON-C displays continuously tests the connection with the controller and immediately displays an alert if the connection is lost.

This allows you to ensure the accuracy of displayed information, with real or near real time data, and eases troubleshooting tasks.

IP65 Electrical Panel Mounting

The HORIZON Series display is shipped with a panel mounting kit. Modify the cabinet door or panel using the provided cutout sheet with an aperture into which the display is inserted, allowing the screen to be securely tightened for a sealed installation.

This mounting method provides an IP65 environmental rating.

IP20 In-Wall Mounting

An optional in-wall mounting kit can be purchased for the HORIZON Series display. The kit is mounted into a wall cavity and it provides an IP20 environmental rating.

An anti-theft cable lock is provided with the in-wall mounting kit for enhanced security.

myDC Control App

myDC Control app is embedded in all HORIZON Series models, allowing you to view, set, and override values of inputs and outputs, view active system alarms, adjust setpoints and override equipment and occupancy, change the system operating schedule, etc...

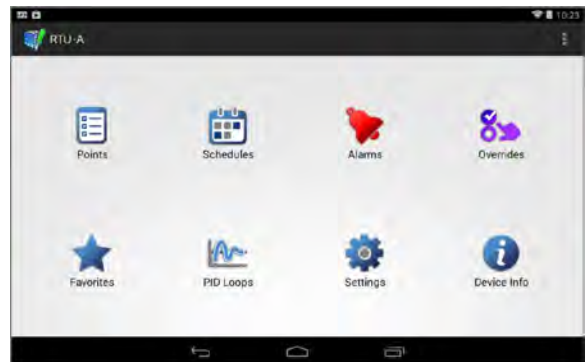

No need for extra programming, the different interfaces are automatically generated from ECLYPSE controllers or EC-Net systems.

Model Selection

HORIZON-C IP-based capacitive multi-touch color displays

HORIZON-C7	7" capacitive multi-touch color display
HORIZON-C10	10.1" capacitive multi-touch color display

Accessories

HORIZON-C7 In-Wall Mounting Kit	Low profile metal mounting box for the HORIZON-C7 display
HORIZON-C10 In-Wall Mounting Kit	Low profile metal mounting box for the HORIZON-C10 display
HORIZON Power Adapter	100-240 VAC, multi-prong, universal wall adapter for the HORIZON Series displays. US, European, UK and Australian plugs included.
HORIZON Power Cable	1m (3.3") cable for powering HORIZON Series displays from the ECLYPSE Connected System Controller or the ECY-PS power supply modules.

Product Specifications

Power Supply

Voltage _____ 24 VAC/DC; $\pm 15\%$; Class 2
or via HORIZON Power Cable

Power consumption

HORIZON-C7

- DC power supply _____ 16 W
- AC power supply _____ 21 VA

HORIZON-C10

- DC power supply _____ 18 W
- AC power supply _____ 24 VA

Operator Interface

Type _____ TFT LCD capacitive touchscreen

Resolution:

- HORIZON-C7 _____ 1024 x 600 WSVGA
- HORIZON-C10 _____ 1280 x 800 WXGA

Active display area:

- HORIZON-C7 _____ 154 x 86 mm (6.06 x 3.39")
- HORIZON-C10 _____ 217 x 136 mm (8.54 x 5.34)

Colors _____ 16.7 M

Backlight _____ LED

Brightness _____ 350 Cd/m²

Dimming _____ Adaptive brightness, software configurable

Hardware

Processor — Intel® Atom™ x5-Z8350 Processor
(2M Cache) CPU with 64 bit architecture; Quad Core

CPU Speed — 1.44 GHz up to 1.92 GHz

Graphics — Intel® HD 400 Graphics ,12 EU GEN 8, up to 500 MHz

Memory — 2 GB DDR3L-1600
32 GB eMMC (storage)

Supported APIs – DX*11.1/12, Open GL*4.2, Open CL*1.2 OGL ES3.0, H.264, HEVC(decode), VP8

Real Time Clock (RTC) — Yes

Communications

Communication ports — 1 × RJ-45 Ethernet port
4 × USB 2.0 ports (not used)

Ethernet Connection Speed — 10/100/1000 Mbps

Software

Operating System — Android Nougat 7.0

Connectivity requirements — ECLYPSE Controller or EC-Net System

Outputs

Digital (On/Off)

Type — Dry contact

Rating — 24 VAC/DC Class 2; 2.5A max

Sound Output

Type — Buzzer

Decibel Rating:

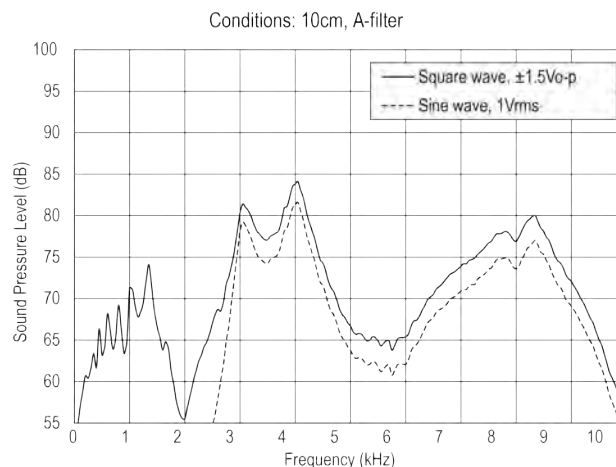

Mechanical

Dimensions:

□ HORYZON-C7 ————— 190 x 126 x 44 mm (7.48 x 4.94 x 1.70")

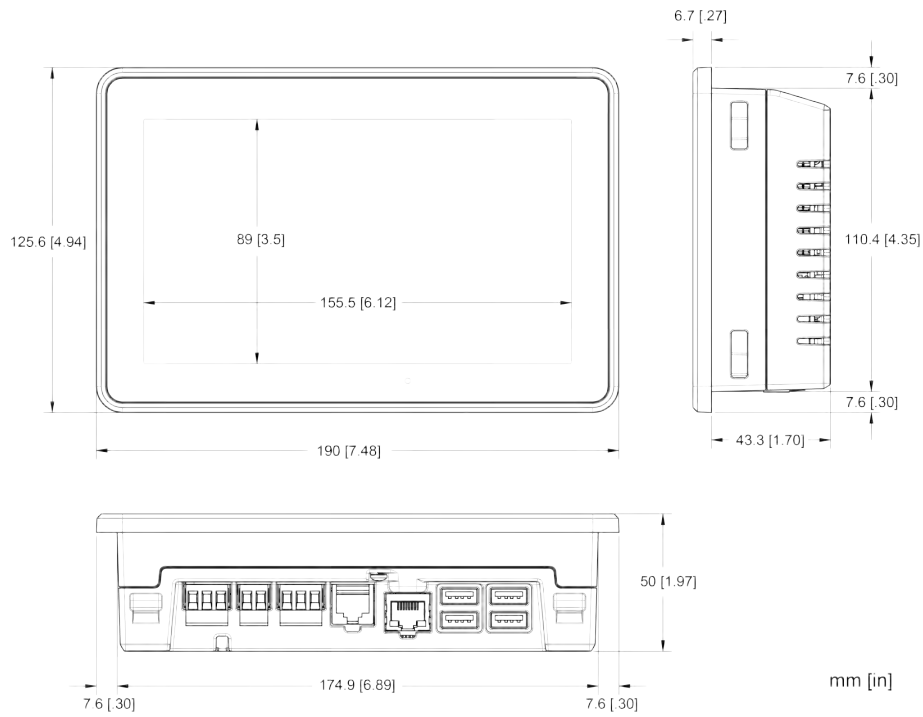

□ HORYZON-C10 ————— 254 x 175 x 44 mm (9.98 x 6.87 x 1.7")

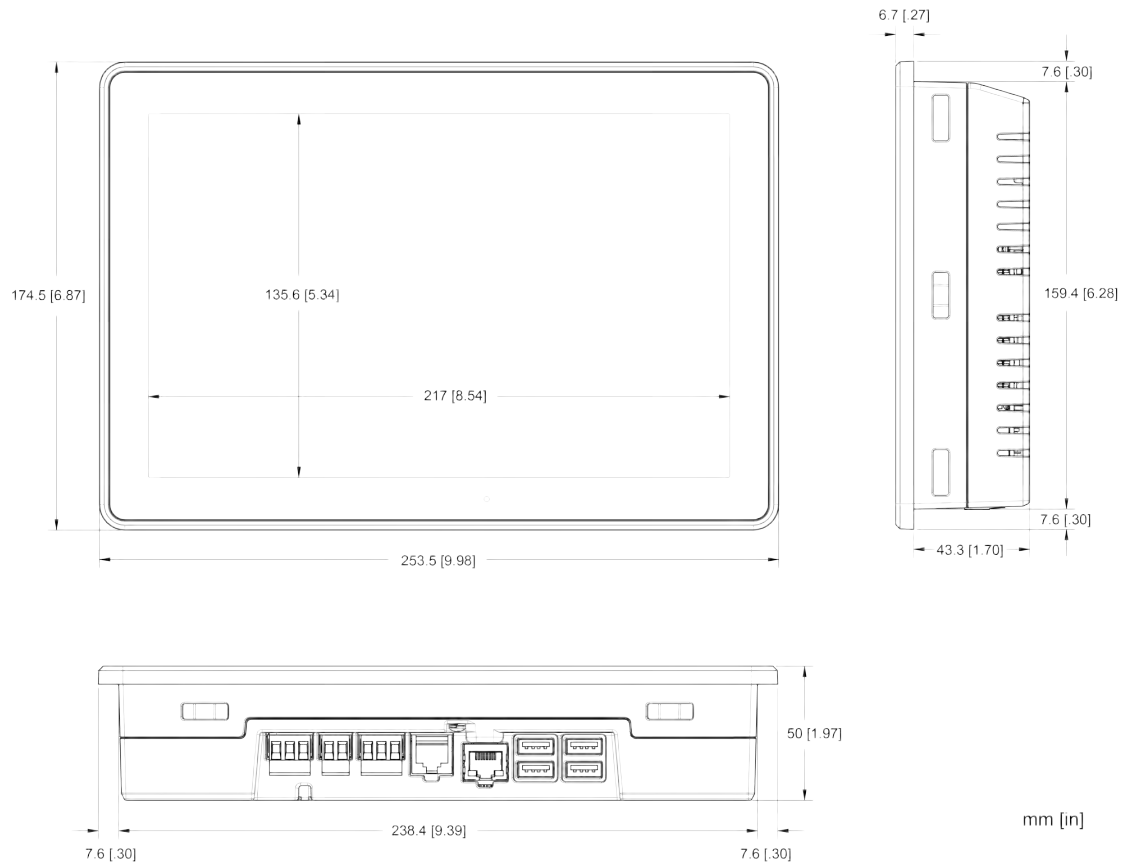

Shipping weight:

- HORYZON-C7 _____ 1.5 kg (2.20lbs)
- HORYZON-C10 _____ 2.2 kg (4.41 lbs)

Material _____ Aluminium

Mounting:

- Electrical panel mounting kit _____ Included
- In-wall mounting kit _____ Optional

Optional in-wall mounting kits dimensions:

- HORYZON-C7 In-Wall Mounting Kit _____ 182.5 x 119.5 x 50 mm (7.19 x 4.70 x 1.97")

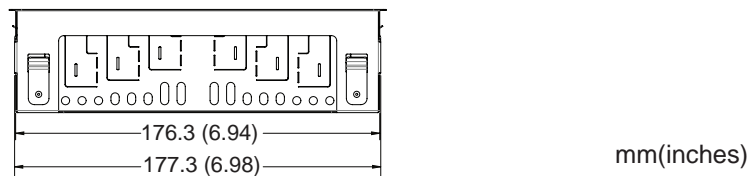
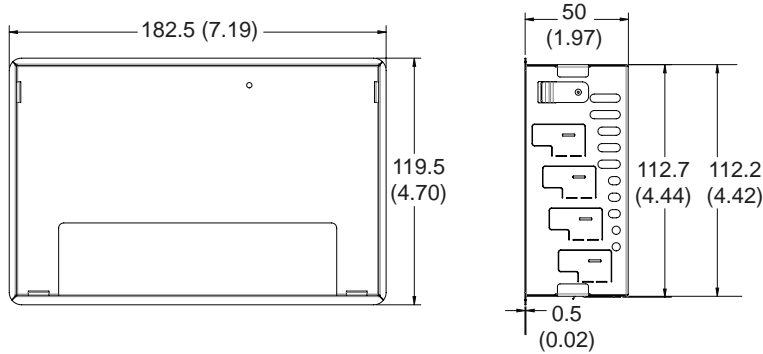

- HORYZON-C10 In-Wall Mounting Kit _____ 246 x 166.7 x 50 mm (9.69 x 6.56 x 1.70")

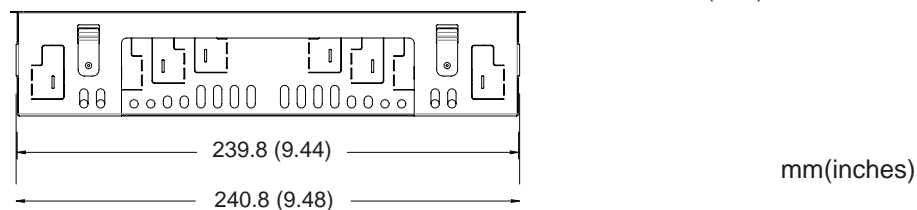
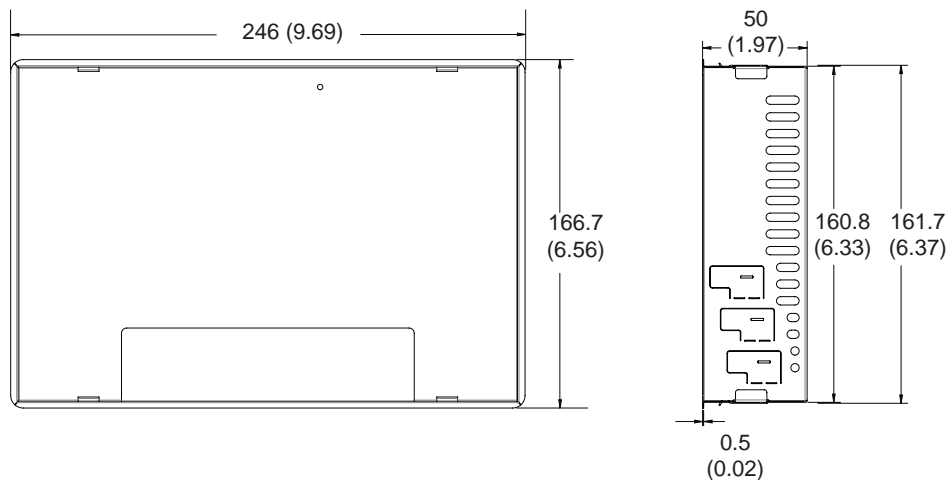

Environmental

Operating Temperature ————— 0°C to 50°C [32°F to 122°F]

Storage Temperature ————— - 20°C to 70°C (32°F to 122°F)

Relative Humidity ————— 0 to 90% Non-condensing

Ingress Protection Rating ————— IP20 if in-wall mounted, IP65 if panel-mounted

Standards and Regulation (pending)

CE - Emission ————— EN61000-6-3: 2007; A1:2011; Generic standards for residential, commercial and light-industrial environments

CE - Immunity ————— EN61000-6-1: 2007; Generic standards for residential, commercial and light-industrial environments

UL Listed (CDN & US) ————— UL916 Energy management equipment

FCC ————— This device complies with FCC rules part 15, subpart B, class B

RoHS ————— All materials and manufacturing processes comply with the RoHS directive.

WEEE ————— All products are marked according to the Waste Electrical and Electronic Equipment (WEEE) directive.



Specifications subject to change without notice.

Distech Controls, the Distech Controls logo, Innovative Solutions for Greener Buildings, EC-Net, ECO-Vue, Allure, and Open-To-Wireless are trademarks of Distech Controls Inc.; LonWorks, LON, and LNS are registered trademarks of Echelon Corporation; BACnet is a registered trademark of ASHRAE; BTL is a registered trademark of the BACnet Manufacturers Association; Niagara^{AX} Framework is a registered trademark of Tridium, Inc.; EnOcean is a registered trademark of EnOcean GmbH. All other trademarks are property of their respective owners.

©, Distech Controls Inc., 2017. All rights reserved.